

**Choice Steel Company
Line Card**

Local Phone # 505-344-4940 Toll Free # 1-877-526-0006

Fax # 505-345-3449 Web Site - choicesteelco.com

Warehouse Located At 7100-B 2nd Street NW

Albuquerque, NM 87107

**A New Mexcio Company, Locally Owned And Operated
Fast & Friendly Service**

Albuquerque Inventory

Angle A-36	1/2" x 1/2" x 1/8" Thru 7" x 4" x 3/8"
Bar Grating 19-W-4 Mesh	1/8" x 1" to 3/16" x 1-1/2" 3' x 20' Bare, Non Serrated
Beams, I A-36/A572GR50	3" Thur 8" Standard Weight 20' & 40' Lengths
Beams, WF A992	4" to 16" Limited Weights, Others Available On Buy Out Basis
Channel, A-36	1" x 1/2" x 1/8" Thru 15" x 33.9# Standard Weights
Expanded Metal Flat	1/8" x #24 Thru 1-1/2" x #9 - Also, 3/4" x #9 Flat Galv. 4' x 8'
Expanded Metal Raised	3/4" x #9, 1-1/2" x #9, And 1-1/2" x #6 4' x 8'
Expanded Metal Grating	3# and 4.27# 4' x 8'
Flat Bars A-36	1/4" x 1/2" Thru 1" x 12"
Pipe Sch 10 Plan End A500 Grade B	1-1/4" and 1-1/2"
Pipe Sch 40 Plan End A500 Grade B	1-1/4" Thru 8"
Pipe Sch 80 Plan End A500 Grade B	1-1/4" Thru 8"
Pipe Sch 40 Plan End A513	1/8" Thru 1"
Pipe Sch 80 Plan End A513	1/2" Thru 1"
Pipe Non-Schedule A500 Grade B	4" x .188 and 6" x .188
Pipe Corral	2-3/8" O.D. x 12ga. & 10ga.
Plate, HR A-36	3/16" Thru 2"
Plate, AR400	3/16" Thru 1/2"
Plate, T-1 A514	3/16" Thru 1/2"
Plate, Floor	14ga Thru 3/8"
Sheet, HR A1011	16ga. Thur 10ga. 48", 60", & limited 72" wide
Sheet, CR A1008	24ga. Thur 10ga. 48" wide
Sheet, Galvanized G-90	28ga. Thur 10ga. 48" wide
Sheet, Electro Galvanized (Paint Loc)	24ga. Thur 16ga. 48" wide
Sheet, Perforated	24ga. 1/16 Dia. On 1/8" Staggered Centers
Square, HR A-36	3/8" Thur 2"
Square, CR 1018	1/8" Thur 1"
Strip, HR A-36	1/8" x 1/2" Thur 3/16" x 12"
Tubing, Rectangular A513 & A500	1" x 1/2" x 16ga. Thur 8" x 6" x .250
Tubing, Round Electric Weld A513	3/8" x 18ga. Thur 4" x .11ga.
Tubing, Round DOM A513 Type 5	Available On Buy Out Basis
Tubing, Square A513 & A500	1/2" x 16 ga. Thru 8" x .375
Twist Bar Square	3/8" and 1/2"

**Ornamental Iron Accessories And Hardware
Metallic Finishes & Coatings, Copper & Easy Rust Oxidizers
We Welcome Inquiries On Non Stock Items**

**No Order Dollar Minimum For Quick Will Call Service
Delivery Available Twice a Day In Albuquerque Area
Also Servicing Northern, Western And Southern New Mexico In Larger Population Areas
We Will Sell 1/2 Pieces Of Most Items
Sawing, Shearing, Brake/Forming, CNC Plasma Burning**

Arrows ▲ ▼ Denote Steel Weld Tabs Placement

ALUMINUM PICKET CASTINGS

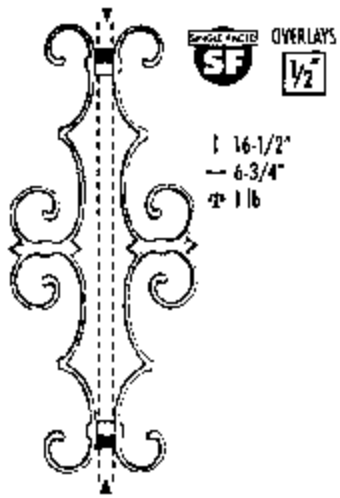

A 1/2"

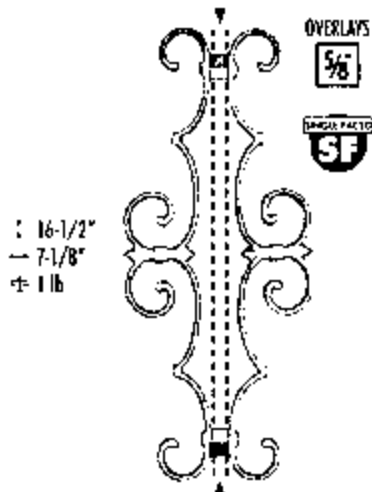

A 5/8"

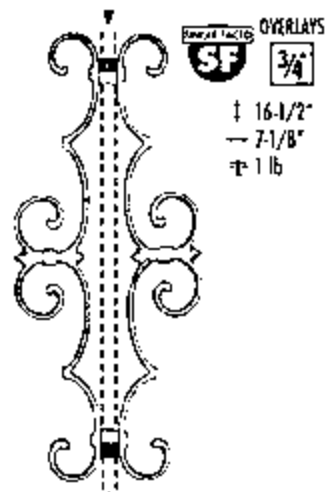

A 3/4"

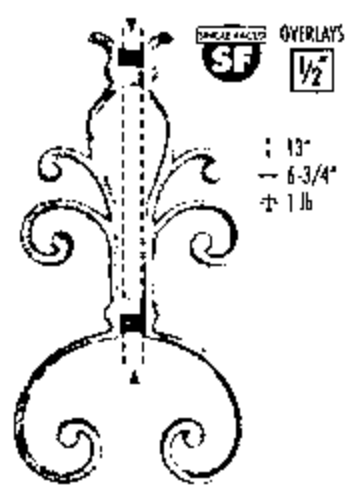

B 1/2"

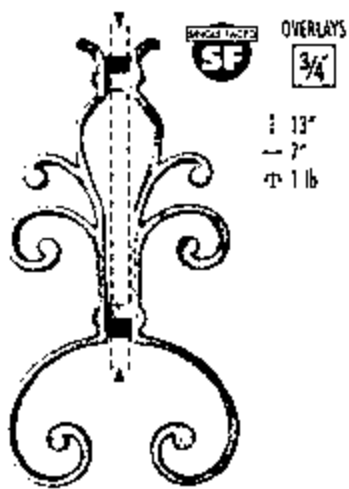

B 1/2"

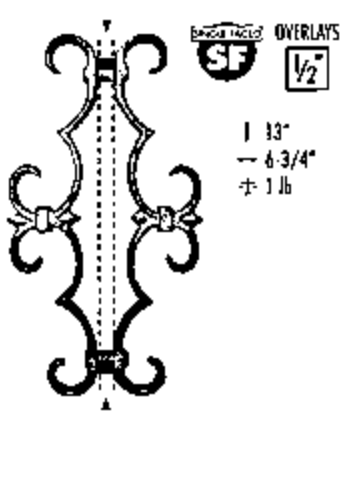

C 1/2"

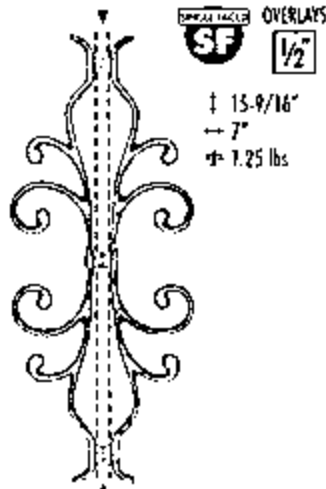

D 1/2"

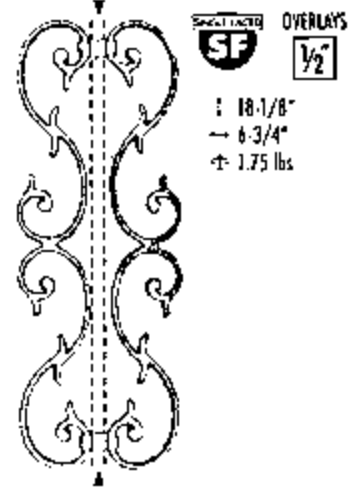

E 1/2"

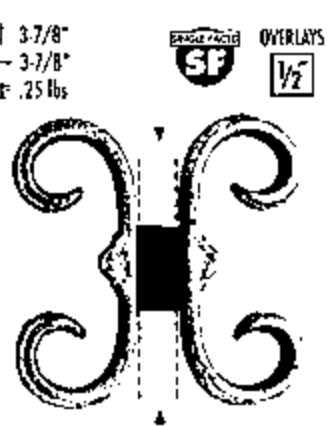

F 1/2"

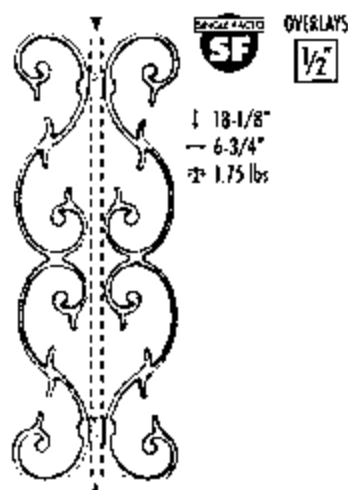

G 1/2"

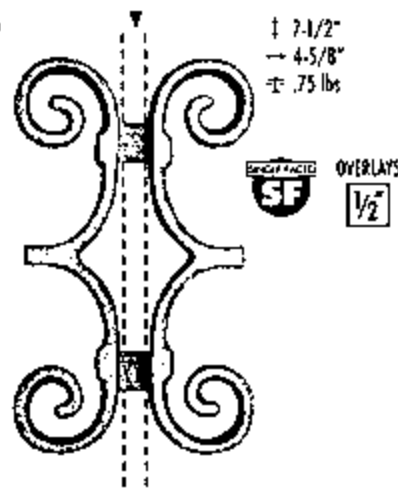

H 1/2"

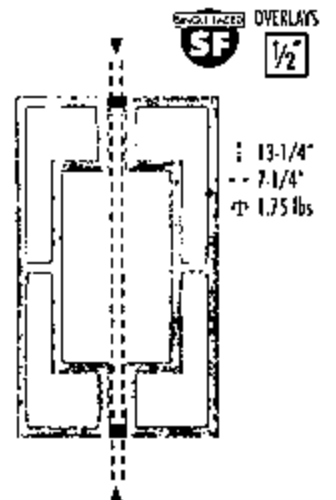

J 1/2"

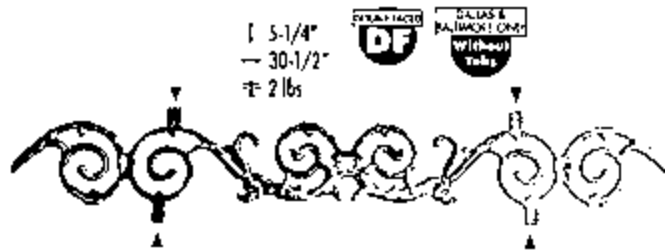

FRIEZE

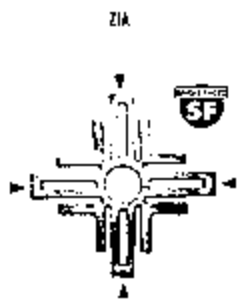

1 10"
→ 10"
± 5/8"
± 1.2 lbs

SMALL

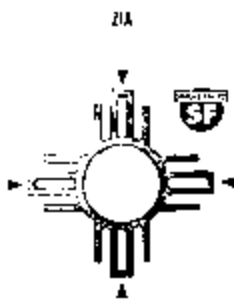

1 11-3/8"
→ 11-3/8"
± 5/8"
± 1.3 lbs

MEDIUM

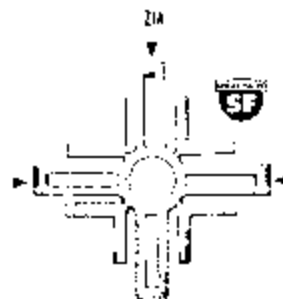

1 17-7/8"
→ 17-7/8"
± 5/8"
± 2.4 lbs

LARGE

UNBREAKABLE SNAP-ONS FOR 1/2" BAR OR TUBE



35/1
Mtl 1/2" x 1 1/4"
8 1/16" W x 17 1/2" H
Wt. 2.7 lbs.



37/3
Mtl 1/2" x 1-1/4"
3 3/4" W x 3 3/4" H
Wt. .6 lb.

ALL HOLLOW SPHERES
HAVE A
1/8" WEEP HOLE



WEEP HOLE

Hollow Steel Spheres

BALL DIAMETER	THICKNESS	WEIGHT
1-3/2"	.118"	.29 lbs.
2"	.118"	.40 lbs.
2-3/8"	.118"	.54 lbs.
3"	.118"	1.10 lbs.
4"	.118"	1.76 lbs.
5"	.118"	2.20 lbs.
6"	.118"	3.00 lbs.
8"	.118"	5.64 lbs.
12"	.118"	12.42 lbs.

Hot-Stamped Steel Smooth Texture



BALL DIAMETER	WEIGHT
3/4"	.07 lbs.
1"	.14 lbs.
1-3/16"	.26 lbs.
1-9/16"	.58 lbs.
1-15/16"	1.13 lbs.

ROSETTES

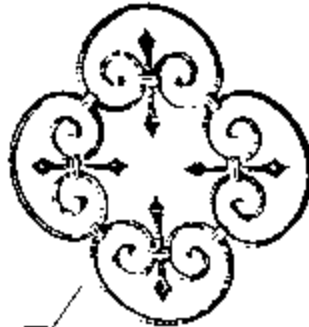

24/3
Mtl 1/2" sq.
23 5/8" dia.
Wt. 13 lbs.



17/2
Mtl 5/16" sq.
9 7/8" dia.
Wt. 2 lbs.

FORGED STEEL BASKETS WITH PLAIN SQUARE BAR FILAMENTS

HEIGHT	WIDTH	ENDS	WEIGHT
4-15/16"	2-3/8"	1/2"	.44 lbs.
7-7/16"	3-9/16"	3/4"	1.67 lbs.



CAST IRON SPEARS & FINIALS

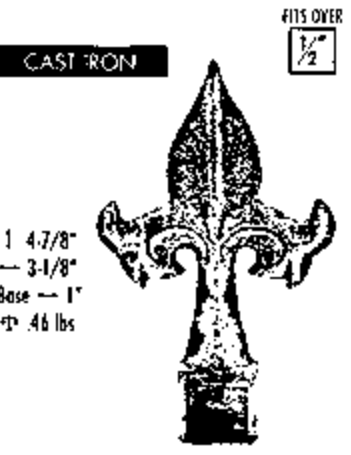

ARROW 1/2"

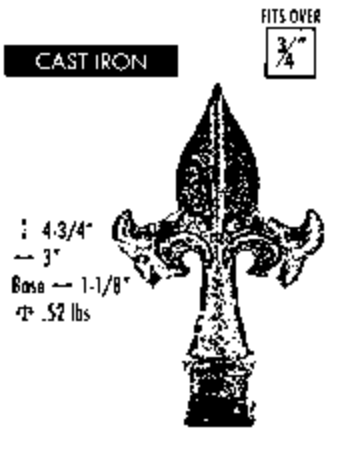

ARROW 3/4"

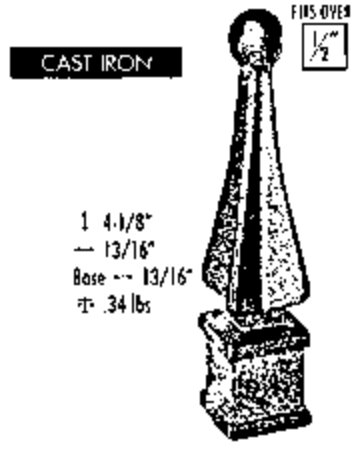

BALL 1/2"

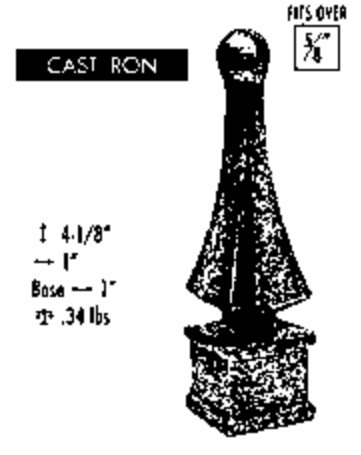

BALL 5/8"

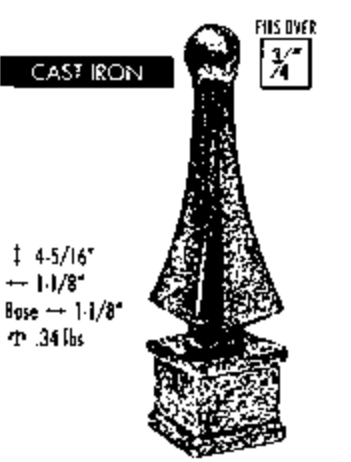

BALL 3/4"

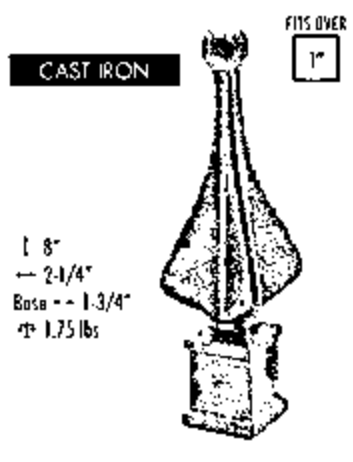

BALL 1"

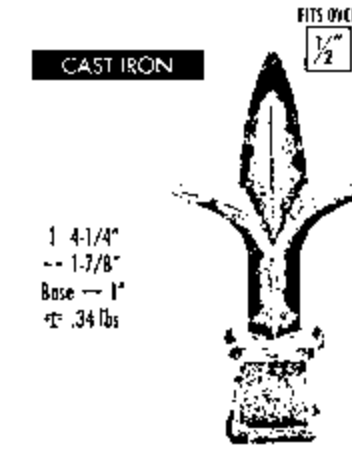

BANANA 1/2"

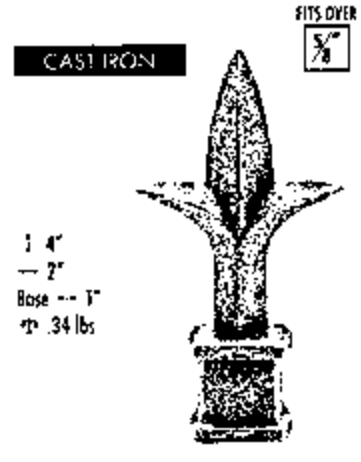

BANANA 5/8"

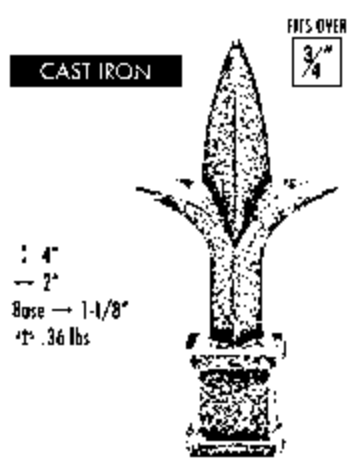

BANANA 3/4"

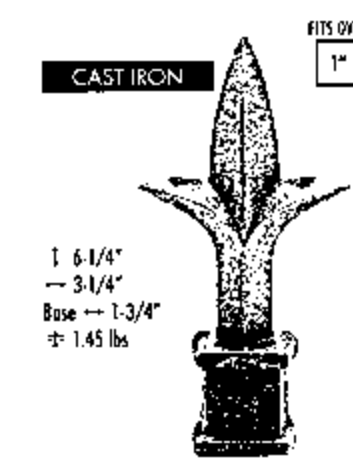

BANANA 1"

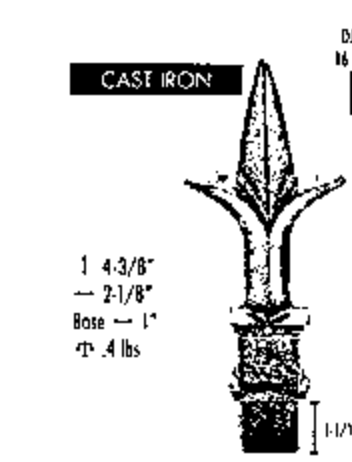

BANANA DRIVES 1"

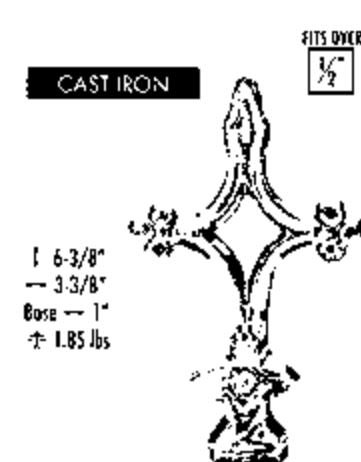

DIAMOND 1/2"

CAST IRON SPEARS & FINIALS

CAST IRON

FITS OVER
1/2"



↑ 5-3/8"
→ 3-1/4"
Base → 1"
± .7 lbs

FANCY 1/2"

CAST IRON

FITS OVER
1/2"



↑ 4-1/4"
→ 1"
Base → 1"
± .3 lbs

PLAIN 1/2"

CAST IRON

FITS OVER
5/8"



↑ 4-1/4"
→ 1"
Base → 1"
± .3 lbs

PLAIN 5/8"

CAST IRON

FITS OVER
3/4"



↑ 4-1/4"
→ 1-1/8"
Base → 1-1/8"
± .32 lbs

PLAIN 3/4"

CAST IRON

FITS OVER
1/2"



↑ 4-1/4"
→ 2-3/8"
Base → 1"
± .44 lbs

ROCKET 1/2"

CAST IRON

FITS OVER
3/4"



↑ 4"
→ 2-3/8"
Base → 1-1/8"
± .36 lbs

ROCKET 3/4"

- Spears Tapered For Tight Fit • No Welding Or Glue Required
- We Recommend That These Spears Not Be Painted • UV Resistant Polypropylene

BALL



Black • White

FITS OVER	HEIGHT	WIDTH	BASE	COLOR
1/2"	4-1/4"	1-1/8"	1"	BLACK
1/2"	4-1/4"	1-1/8"	1"	WHITE
5/8"	4-1/4"	1-1/8"	1"	BLACK
3/4"	4-1/4"	1-1/8"	1"	BLACK

PLASTIC

1/2" 5/8" 3/4"

BANANA



Black • White

FITS OVER	HEIGHT	WIDTH	BASE	COLOR
1/2"	4-1/2"	2-1/4"	1-3/16"	BLACK
1/2"	4-1/2"	2-1/4"	1-3/16"	WHITE
5/8"	4-3/2"	2-1/4"	1-3/16"	BLACK
3/4"	4-1/2"	2-1/4"	1-3/16"	BLACK
3/4"	4-1/2"	2-1/4"	1-3/16"	WHITE

PLASTIC

1/2" 5/8" 3/4"

Cast Iron Newel Post Balls



FITS OVER	HEIGHT	BASE	BALL DIAMETER	WEIGHT
1"	2-1/4"	1-1/4"	7/8"	.46 lbs
1-1/4"	2-1/2"	1-1/2"	1-1/8"	.56 lbs
1-1/2"	2-3/4"	1-3/4"	1-3/8"	.66 lbs
2"	3-3/4"	2-3/8"	1-3/4"	1.35 lbs
2"	3-3/4"	2-3/8"	1-13/16"	1.50 lbs
2-1/2"	4-3/8"	3"	2"	2.63 lbs
3"	5"	3-1/2"	2-1/2"	3.25 lbs
3"	5"	3-1/2"	2-1/8"	3.10 lbs
4"	5-1/2"	4-1/2"	3"	4.66 lbs
4"	5-1/2"	4-1/2"	2-1/2"	4.51 lbs
6"	7-1/2"	6-1/2"	4"	8.10 lbs

CAST IRON POST CAPS

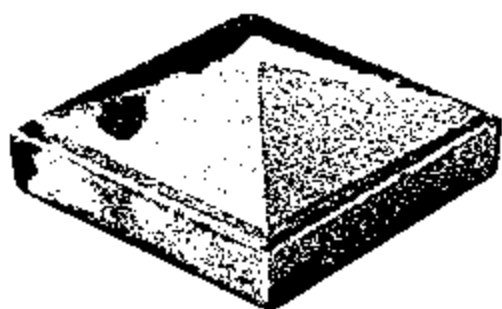

FITS OVER	BASE	WEIGHT EA.
1" x 1" SQUARE	.13	.130 lbs
1-1/4" x 1-1/4" SQ	.21	.20 lbs
1-1/2" x 1-1/2" SQ	.23	.25 lbs
2" x 2" SQ	.36	.414 lbs
2-1/2" x 2-1/2" SQ	1.16	.65 lbs
3" x 3" SQ	.67	.95 lbs
4" x 4" SQ	1.26	1.20 lbs
6" x 6" SQ	5.07	3.35 lbs

PLASTIC TUBING PLUGS

SIZE	WEIGHT	GAUGE
1/2" SQ	.01	16
1/2" SQ WHITE	.01	16
5/8" SQ	.01	16
3/4" SQ	.01	16
1" SQ	.007	16
1" SQ WHITE	.01	16
1-1/4" SQ	.009	16
1-1/2" SQ	.015	16
2" SQ	.021	16
2" x 1"	.012	16



PRESSED POST CAPS

THESE FIT RADIUS CORNER TUBING



FITS OVER	WEIGHT EA.
3/4" x 3/4" SQ	.016 lbs
1" x 1" SQ	.020 lbs
1-1/4" x 1-1/4" SQ	.034 lbs
1-1/2" x 1-1/2" SQ	.046 lbs
2" x 2" SQUARE	.090 lbs
2-1/2" x 2-1/2" SQ	.160 lbs
3" x 3" SQUARE	.140 lbs
3-1/2" x 3-1/2" SQ	.406 lbs
4" x 4" SQ	.308 lbs
5" x 5" SQ	.412 lbs
6" x 6" SQ	.536 lbs

ALL ARE 19 GA.

STEEL

90° WELDABLE ELBOWS

PIPE SIZE	O.D.	CENTERLINE RADIUS	INSIDE RADIUS
3/4"	1-1/16"	1.1"	60°
1"	1 5/16"	1.5"	80°
1-1/4"	1 5/8"	1.9"	1.1"
1-1/2"	1-7/8"	2.25"	1.35"
2"	2-3/8"	3.0"	1.8"
2-1/2"	2-7/8"	3.75"	2.3"
3"	3-1/2"	4.5"	2.75"
4"	4 1/2"	6.0"	3.75"
6"	6-5/8"	9.0"	5.7"



- WELDABLE STEEL
- SCHEDULE 40
- BLACK FINISH
- BEVELED EDGES



BEVELED PIPE END-CAPS

- WELDABLE STEEL PIPE END-CAPS
- BEVELED EDGES
- BLACK FINISH
- SCHEDULE 40

PIPE SIZE	O.D.
1"	1-5/16"
1-1/4"	1 5/8"
1-1/2"	1-7/8"
2"	2-3/8"
2-1/2"	2 7/8"
3"	3-1/2"
3-1/2"	4"
4"	4-1/2"
6"	6-5/8"



Centerline Radius

- WELDABLE STEEL
- SCHEDULE 40
- BLACK FINISH
- BEVELED EDGES

45° WELDABLE ELBOWS

PIPE SIZE	O.D.	CENTERLINE RADIUS	INSIDE RADIUS
1-1/4"	1-5/8"	1.9"	1.1"
1-1/2"	1-7/8"	2.25"	1.35"

HAMMERED 4 CORNERS STEEL TUBING



FRACTION APPROX	DECIMAL EXACT	WALL THICKNESS		LENGTH	WEIGHT PER FT 8' OR 19'
		mm	Inches		
1/2"	.50"	1.30 mm	(.051")	19'	.25 / 5.02 lbs
3/4"	.787"	2.00 mm	(.079")	19'	.70 / 13.40 lbs
1"	.984"	2.50 mm	(.098")	19'	1.20 / 23.30 lbs
1-3/16"	1.18"	2.50 mm	(.098")	19'	1.41 / 26.57 lbs
1-1/2"	1.579"	2.00 mm	(.079")	19'	1.52 / 30.20 lbs
2"	1.97"	2.00 mm	(.079")	19'	1.94 / 38.33 lbs
2" x 1"	1.97" x .984"	2.00 mm	(.079")	19'	1.45 / 25.83 lbs

PUNCHED STRUCTURAL STEEL BAR CHANNEL



DESCRIPTION	CENTERLINE HOLE SPACING	DISTANCE BETWEEN HOLES	FITS	LENGTH	WT PER FT	WT PER 20 FT
1" x 1/2" x 1/8"	4"	3-1/2"	1/2" ■	20'	.84 lbs	16.80 lbs
1" x 1/2" x 1/8"	6"	5-1/2"	1/2" ■	20'	.84 lbs	16.80 lbs
1-1/2" x 1/2" x 1/8"	4"	3-1/2"	1/2" ■	20'	1.12 lbs	22.40 lbs

HAMMERED 4 EDGES FLAT BAR

SIZE	LENGTH	WEIGHT
1/4" x 1/2"	8'	3.084 lbs
1/4" x 3/4"	8'	5.06 lbs



HOT - HAMMERED SOLID STEEL ROUND BAR

SIZE	METRIC SIZES	WEIGHT
3/8"	10 mm	3.35 lbs
1/2"	12 mm	4.75 lbs



HAMMERED ROUND BAR (TREE BARK EFFECT)

SIZE	WEIGHT
5/16"	2.1 lbs
1/2"	4.75 lbs

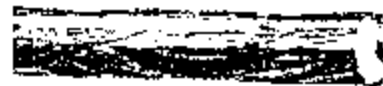

HAMMERED ON 4 CORNERS SOLID BAR

DESCRIPTION	FAMILY CODE	METRIC DIMENSIONS	LENGTH	WEIGHT PER FT
Hammered Solid Bar 1/2" (4724)	F	12 mm Sq	19'	0.76 / 14.38 lbs

PICKETS



105/2
Mtl 1/2" sq.
39 1/2" H
Wt. 3 lbs.



105/3
Mtl 9/16" sq.
39 1/2" H
Wt. 3.5 lbs.

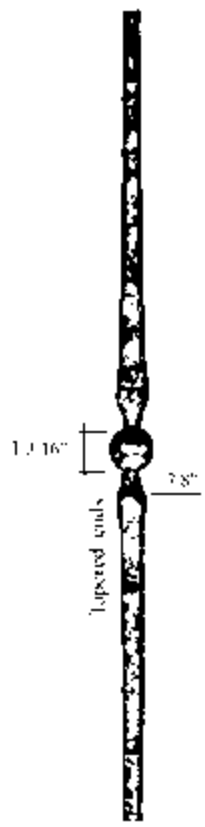

109/3
39 1/2" H
Wt. 4.1 lbs.



70/D/5
Mtl 9/16" sq.
35 7/16" H
Wt. 3.4 lbs.



47/12
Mtl 9/16" sq.
35 7/16" H
Wt. 3.1 lbs.



47/11
Mtl 9/16" sq.
2 1/8" W x 35 7/16" H
Wt. 3.3 lbs.



64/H/10
Mtl 9/16" sq.
1 3/16" W x 35 7/16" H
Wt. 3.1 lbs.



53-3
Double Twist
1/2" SQUARE
35 1/2"
2.5 lbs.



65-8
Single Twist
1/2" SQUARE
35 1/2"
2.5 lbs.



50/6
Mtl 1/2" sq.
1 3/16" W
x 35 7/16" H
Wt. 2.2 lbs.

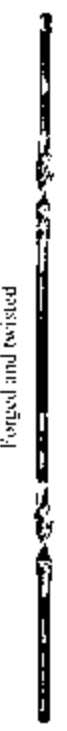

50/6
Mtl 1/2" sq.
1 3/16" W
x 35 7/16" H
Wt. 2.2 lbs.



48/4
Mtl 1/2" sq.
35 7/16" H
Wt. 2.4 lbs.

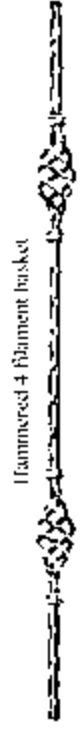

48/3
Mtl 1/2" sq.
35 7/16" H
Wt. 2.6 lbs.



48/2
Mtl 1/2" sq.
35 7/16" H
Wt. 2.4 lbs.

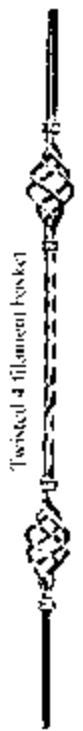

48/1
Mtl 1/2" sq.
35 7/16" H
Wt. 2.6 lbs.



64/F/3
Mtl 9/16" sq.
35 7/16" H
Wt. 3 lbs.

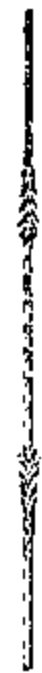

64/F/5
Mtl 9/16" sq.
35 7/16" H
Wt. 3 lbs.

PICKETS



62/1
 Mtl 3/4" x 1/4"
 9 1/4" W x 28 3/8" H
 Wt. 5.2 lbs.



70/1/1
 Mtl 9/16" sq.
 35 1/16" H
 Wt. 3 lbs.

Bushings: A/c. 128/2



64/1/2
 Mtl 9/16" sq.
 35 7/16" H
 Wt. 3.6 lbs.



64/1/3
 Mtl 9/16" sq.
 35 7/16" H
 Wt. 3.3 lbs.



Hammered edges

597/3
 Mtl 9/16" sq.
 35 7/16" H
 Wt. 3 lbs.

STEEL HANDRAIL BRACKET

FOR FLAT OR ROUND MATERIAL

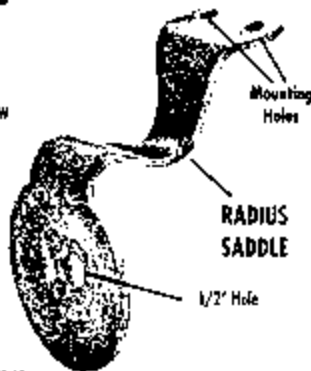
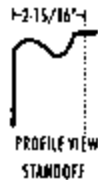

3 7/8"
 2 3/4"
 Standoff: 2-15/16"
 (Extends 2-15/16"
 from Wall to Saddle Centerline)
 ± .52 lbs

HANDRAILS

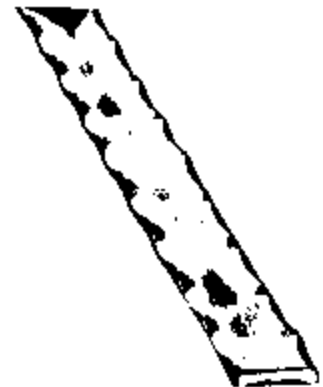

114/9
 Mtl 1 3/16" x 5/16"
 L 10" Approx
 Wt. 12.8 lbs.

MOLDED STEEL HANDRAIL & ACCESSORIES

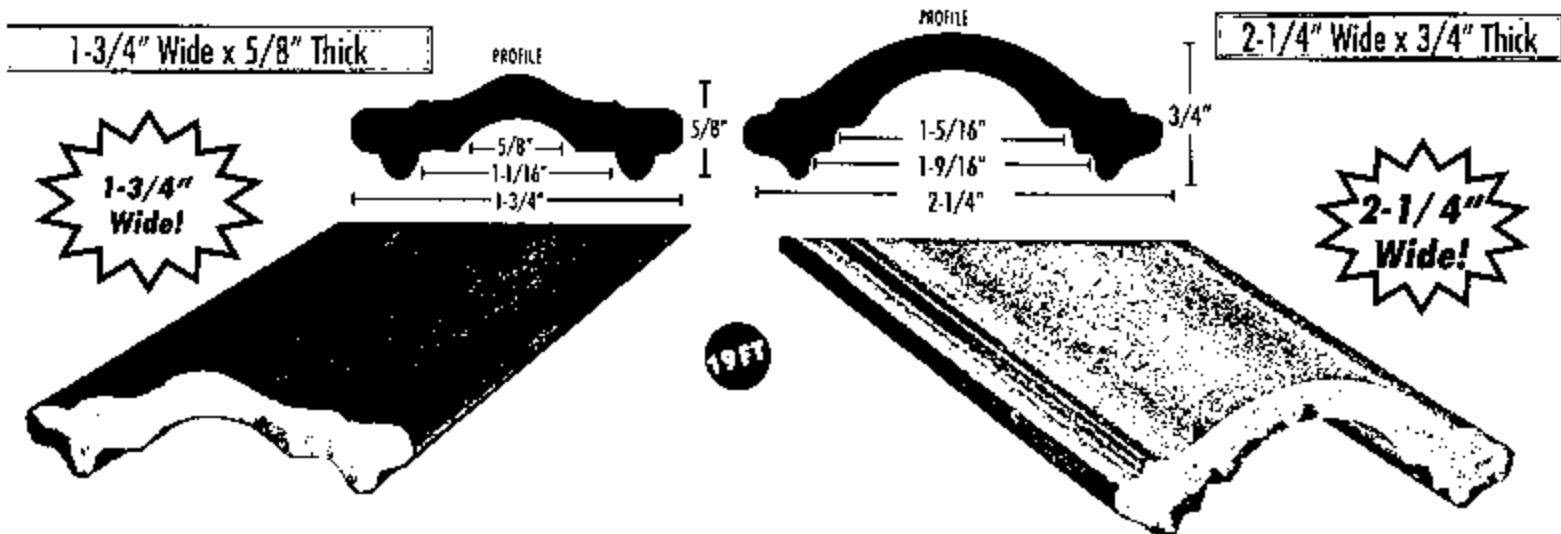

MOLDED STEEL

VOLUTE



↓ 5 7/8"
⊕ 3.02 lbs

MOLDED STEEL

VOLUTE



↓ 6 5/16"
↔ 11 1/4"
⊕ 4.34 lbs

HANDRAILS

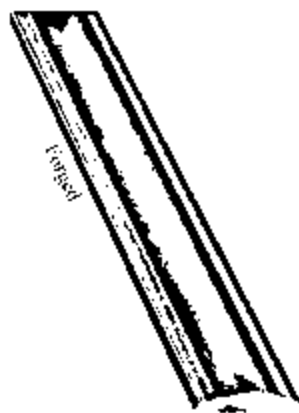

114/A/3
Mtl 2" x 9/16"
L 10' Approx
Wt. 29 lbs.

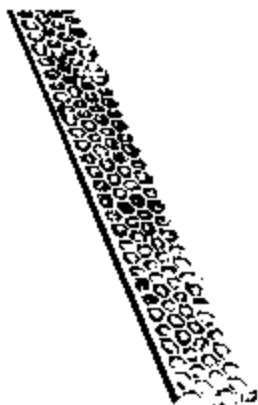

114/4
Mtl 1 9/16" x 5/16"
L 10' Approx
Wt. 16.5 lbs.



114/1
Mtl 2 9/32" x 9/16"
L 78 3/4"
Wt. 28 lbs.

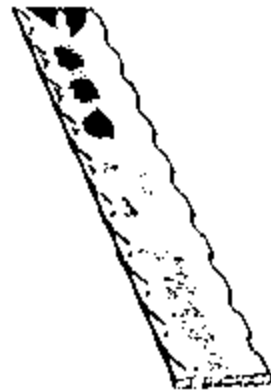

114/8
Mtl 1 9/16" x 5/16"
L 10' Approx
Wt. 16.5 lbs.



114/5
Mtl 1 9/16" x 5/16"
L 10' Approx
Wt. 16.5 lbs.

HANDRAILS



5 7/8" L.
11 13/16" H

116/10- Wt. 3 lbs.
for handrail Art 114/5

116/13- Wt. 3 lbs.
for handrail Art 114/8

116/9- Wt. 3 lbs.
for handrail Art 114/4



5 7/8" L.
11 13/16" H

114/B/13
for handrail Art 114/A/3
Wt. 5.8 lbs.



5 7/8" L.
11 13/16" H

115/4
for handrail Art 114/1
Wt. 8.2 lbs.



TUBULAR HANDRAILS & ACCESSORIES

1-3/4" Wide x 1-1/8" Thick

MADE IN USA

45-906

20 FT SECTIONS / 23 lbs. Ea

SOFT

1-3/4"
Wide

CONFORMS IN SHAPE TO CONVENTIONAL
1-3/4" WIDE MOLDED COVER RAIL
COMBINED WITH 1" CHANNEL

14 GAUGE TUBULAR
STEEL HANDRAIL



29 mm
1-1/8"

44 mm
1-3/4"

CAST IRON
FOR PINCHED RAIL

Plugs 1/4" deep into
tubular handrail.
(Dimensions do NOT
include plug).



1 3-1/2"
→ 1-11/16"
± 1.25 lbs

CAST IRON
STRAIGHT

Plugs 1/4" deep into
tubular handrail.
(Dimensions do NOT
include plug).



1 4-5/16"
± 1.2 lbs

CAST IRON

For 1-5/8" and
1-3/4" molded or
tubular handrail
(45-905, 45-905-8,
45-905-1B, 45-906)

1 1-1/32"
→ 2-5/16"
↘ 3-3/4"
± .47 lbs



Will NOT fit
2-1/4" molded

1/4" & 5/16" ONE-WAY SCREWS



1/4" Screws
LARGE
7/16" HEAD

SIZE	WEIGHT
1/4" x 2"	.022
1/4" x 3"	.031
5/16" x 2"	.034
5/16" x 3"	.048
5/16" x 4"	.062

5/16" Screws
LARGE
9/16" HEAD

- BLACK OXIDE FINISH
- HEAT TREATED
- TRUSS HEAD

- TYPE A
- THREADED FULL LENGTH
- CAN BE INSTALLED WITH SCREWDRIVER



T-40 HEAD

1/4" TORXS TAMPER-RESISTANT SCREWS

- BLACK OXIDE FINISH
- HEAT TREATED
- T-40 SIZE HEAD
- THREADED FULL LENGTH

SIZE	WEIGHT
1/4" x 1-1/2"	.020
1/4" x 2"	.024
1/4" x 3"	.033

PLEASE NOTE: SCREWS CAN ONLY BE INSTALLED OR REMOVED WITH SPECIAL TOOL (36-1-T40) SEE PAGE 593

POWER BITS FOR ONE-WAY SCREWS WITH FINDER SLEEVE



Power Bit

ITEM #	FITS	WEIGHT
36-2	5/16"	.294

TORX-HEAD POWER BITS BIT INSERT HAS 1/4" HEX SHANK



TORX INSTALLATION BIT 36-1-T40
WORKS WITH HEX HEAD BITS ±.012 lbs

STEEL BASE PLATES



**CUSTOM SIZES
AVAILABLE ON REQUEST**

SIZE	HOLES	THICKNESS	BOX QTY	WEIGHT
3" Sq	3/8"	3/16"	100	.37 lbs.
4" Sq	3/8"	1/8"	100	.70 lbs.
5" Sq	3/8"	1/4"	50	1.50 lbs.
6" Sq	3/8"	1/4"	25	2.32 lbs.
8" Sq	3/8"	1/4"	16	4.00 lbs.
10" Sq	1/2"	5/16"	8	9.47 lbs.

STEEL WELD LABS

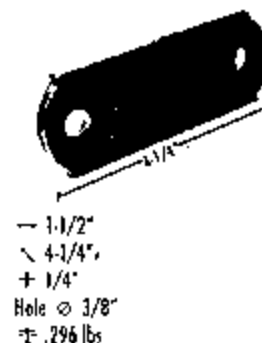
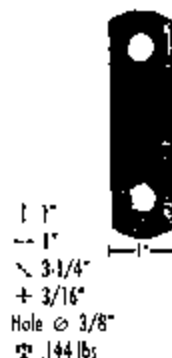
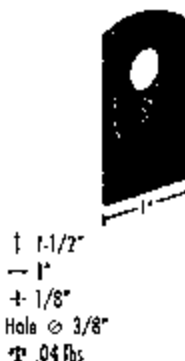
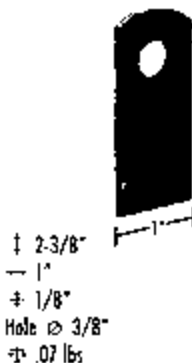
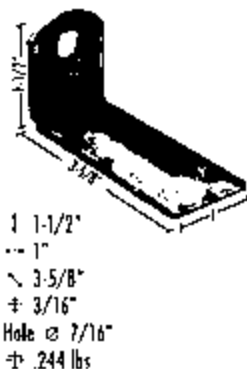
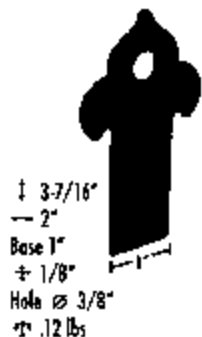

**CANE BOLTS ARE
CADMIUM PLATED**
 Canoe Bolt Brackets Are:
 1-5/8" Wide x 2-7/8"
 Long

18"
 (\pm 1.5 lbs)

1/2" SLIDE BOLT LATCH
 WITHOUT SCREWS; MILL FINISH; 14 GA. STEEL

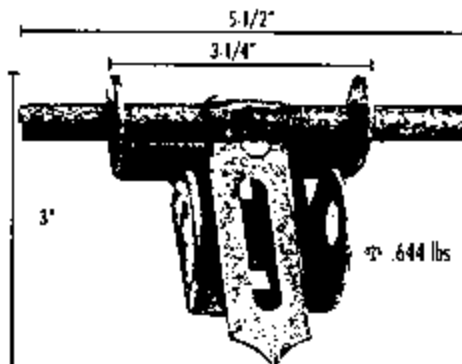

Coupler (Receiver) Not Included

GRAVITY GATE LATCH
 HEAVY-DUTY; 14 GA. STEEL
 WITHOUT SCREW HOLES; MILL FINISH

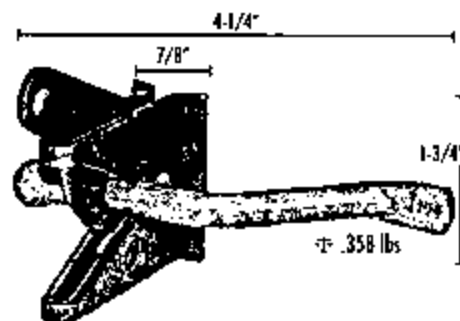

CAST IRON & MALLEABLE BASES & SHOES

FITS OVER

$\frac{1}{2}$ "



1 7/8"
→ 1-1/2" Sq
± .15 lbs

FITS

1"



1 1-3/8"
→ 1-5/8"
↘ 3-3/4"
± .47 lbs

FITS

1 1/4"



1 1-5/16"
→ 2-9/16"
↘ 3-13/16"
± .66 lbs

CAST IRON COLLARS

FITS OVER

$\frac{1}{2}$ "



1 1-3/4"
→ 1-1/2" Sq
± .4 lbs

FITS OVER

$\frac{5}{8}$ "



1 2"
→ 1-3/4" Sq
± .402 lbs

FITS OVER

$\frac{3}{4}$ "



1 1-3/4"
→ 1-7/8" Sq
± .364 lbs

FITS OVER

1"



1 2-1/2"
→ 2-1/2" Sq
± 1.1 lbs

OVERLAYS

$\frac{1}{2}$ "



1 1-3/4"
→ 1-3/4"
± .18 lbs

Collar

FITS OVER

$\frac{1}{2}$ "



1 2-5/8"
∅ 1-3/4"
± .53 lbs

Base

FITS OVER

$\frac{1}{2}$ "



1 1-1/2"
∅ 1-9/16"
± .36 lbs

**PUSH BUTTON
QUICK !!**

LOCK SYSTEM FOR WINDOW GUARDS

Consumers want safety, and the government requires it. That's why home-owners sometimes delay buying wrought iron for doors and windows, unless you can show them a fast way to escape - the quick release lock system. Instead of a key, a push button is installed from the inside, out of reach of burglars. Press the button and the guard opens instantly - an instant that could save lives during a fire.

The new quick release lock system - the way to double your customers safety while you increase your ornamental iron sales.

- Push button release inside
- Easy - Quick installation
- No assembly required on lock mechanism
- Simplicity of design
- Only one small 5/16" bore through wall
- Weatherproofed
- Tamper-proof for added reliability
- Brass rod through wall

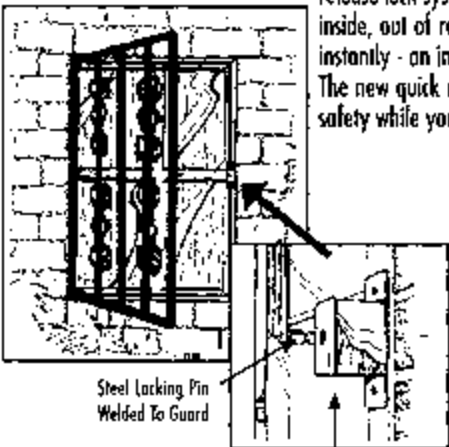

Steel Locking Pin
Welded To Guard

Locking Mechanism Welded
To Window Frame



**2-1/2" Between
Guard and Frame
When Locked**

**Quick Release
Import**

⚖ 1.768 lbs

MANUAL WINDOW GUARD RELEASE

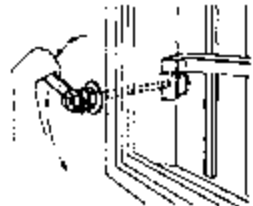

Inside Opening

Requires only 1/2" hole through wall. Spring loaded. Spring remains in cylinder head when window guard is opened. A simple turn of the adjusting nut allows full adjustment for all wall thicknesses. Spring loaded to pop open guard when released. No field welding required. Complete with "D" shaft and "D" hole handle.



7"

⚖ .64 lbs

9"

⚖ .694 lbs

11"

⚖ .752 lbs

MALE BAT WING HINGES WITH 1/2" FEMALE BAT WING HINGES WITH 1/2"

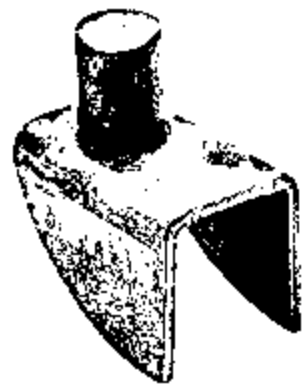

MALE HINGE

- 1 1-1/16"
- 1-1/16"
- ↘ 1-17/32"
- Pin 1 15/16"
- ⚖ .2 lbs



FEMALE HINGE

- 1 1-1/16"
- 1-1/16"
- ↘ 1-17/32"
- ⚖ .1 lbs

Gate Hanger J-Bolts

IN 1/2"

BOLT SIZE	MEASUREMENTS	WEIGHT	WEIGHT PER BOX
1/2"	1/2" X 4-1/2"	.382 lbs	57.3 lbs (150)



***1" BOLT IS GALVANIZED AND
THREADED FULL LENGTH -
2 NUTS INCLUDED**

BARREL HINGES

These specialized hinges are made for a wide variety of applications: The smaller sizes are great for pedestrian gates and barbecue grills, while the larger sizes with stainless steel pins can handle virtually any heavy door or driveway gate.

Barrel Hinge Installation

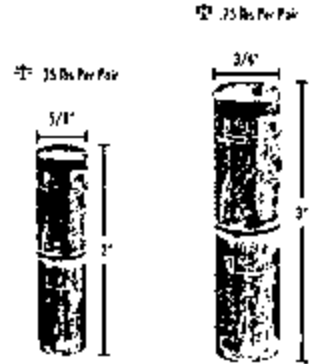
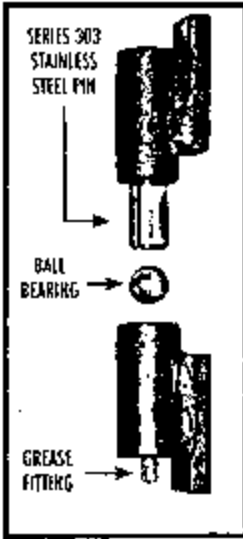

SIZE	WELD PAD	INSTALLATION GAPS	WEIGHT PER PAIR	WEIGHT CAPACITY
5" USA	1" x 2"	1-3/4"	2.75 lbs.	600 lbs.
7" USA	1-1/2" x 3"	2-1/8"	7 lbs.	900 lbs.

SIZE
2" Import
3" Import

ADJUSTABLE BARREL HINGES

Bolt \approx 4-3/8"
(Supports up to 300 lbs)
2 Per Case / 54 lbs

1-5/8"
Clearance between gate & post



5/8" STEEL J-BOLT
BALL BEARING - GREASE FITTING

Bolt \approx 6-3/4"
(Supports up to 600 lbs)
2 Per Case / 48 lbs

2-3/4"
Clearance between gate & post



3/4" STEEL J-BOLT
BALL BEARING - GREASE FITTING

ORNAMENTAL IRON STORM
DOOR WEIGHT HINGE THAT
FEATURES A HAMMERED
FORGED TEXTURE.

-TIGHT PIN
-WELDABLE STEEL
-PAINTED BLACK
2 1.26 lbs.



7" x 2-5/8" x 0.104"

STEEL HINGE BODY- With Brass Pin & Brass ring. NO GREASE FITTING.

SIZE	PIN DIAMETER	BARREL DIAMETER	WEIGHT CAPACITY	WEIGHT
3-3/16"	5/16"	5/8"	240 lbs.	4 lbs/pair
4"	25/64"	5/8"	352 lbs.	7 lbs/pair
7"	3/8"	13/16"	520 lbs.	2.8 lbs/pair

MARR TYPE

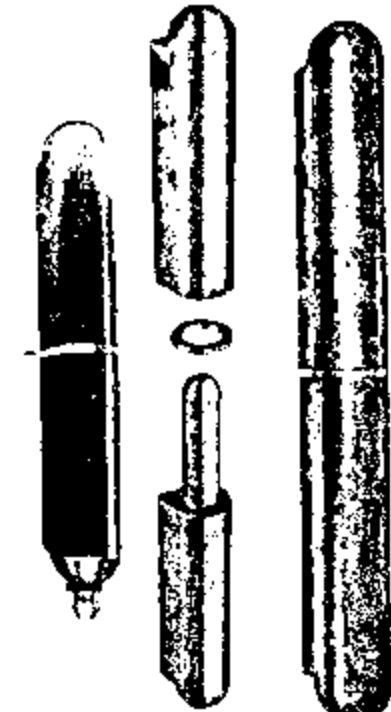
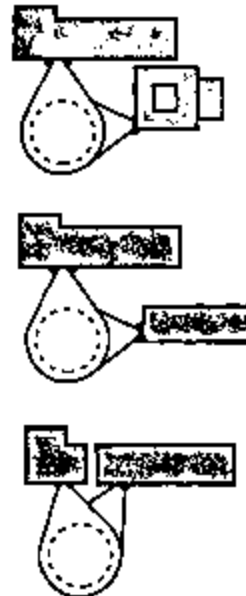

BUTT HINGES

- BRIGHT STEEL
- TIGHT 1/4" PIN
- STANDARD DUTY
- NO SCREW HOLES
- NON SWAGED SURFACE
- NARROW WIDTH
- WELDABLE

2" x 2" x 0.076"

STEEL



± .3 lbs Per Piece
10 Pz Per Box / 3 lbs
200 Pz Per Case / 60 lbs

- BRIGHT STEEL
- TIGHT 5/16" PIN
- STANDARD DUTY
- NO SCREW HOLES
- SWAGED SURFACE
- NARROW WIDTH
- WELDABLE

2-1/4" x 3-1/2" x 0.086"

STEEL

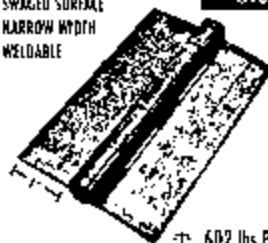

± .602 lbs Per Pc
10 Pz Per Box / 6.02 lbs
100 Pz Per Case / 60.2 lbs

- BRIGHT STEEL
- TIGHT 5/16" PIN
- STANDARD DUTY
- NO SCREW HOLES
- SWAGED SURFACE
- NARROW WIDTH
- WELDABLE

3" x 3" x 0.080"

STEEL



± .62 lbs Per Pc
10 Pz Per Box / 6.2 lbs
100 Pz Per Case / 62 lbs

HEAVY DUTY STEEL HINGE

- NON-SWAGED SURFACE
- TIGHT PIN • BUTT HINGE

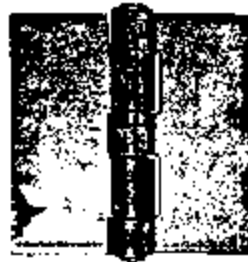

SIZE	PIN SIZE	LEAF SIZE	WEIGHT
4" x 4" x 0.178"	3/8"	1-5/8"	1.2 lbs

SCROLLS

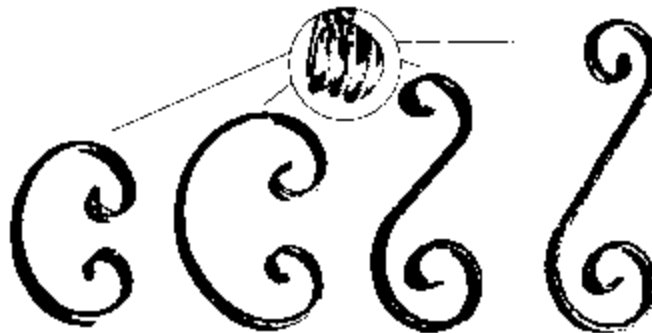

80/A/9
Mtl 1/2" x 1 1/4"
2 1/4" W x 4 1/8" H
Wt. .4 lb.

80/A/10
Mtl 1/2" x 1 1/4"
3 3/4" W x 5 1/2" H
Wt. .5 lb.

80/A/11
Mtl 1/2" x 1 1/4"
2 9/16" W x 5 7/8" H
Wt. .4 lb.

80/A/12
Mtl 1/2" x 1 1/4"
2 3/4" W x 7 1/4" H
Wt. .5 lb.

RUBBER GUIDE ROLLERS

STEEL V-GROOVE WHEEL BOXES RUGGED 11 & 13 GAUGE STEEL PRE-DRILLED FOR AXLES

3" RUBBER GUIDE ROLLER

1 3"
-- 2-3/8"
± 1.354 lbs

6" RUBBER GUIDE ROLLER

1 6"
-- 2-3/8"
± 2.474 lbs



Rugged Weldable Steel
Mounting Bracket
- With Bearings -
Non-Removable Pin



1 3"
-- 2"
\ 5"
Hole ∅ 1/2"
± 1.5 lbs

1 3-7/8"
-- 3"
\ 7"
Hole ∅ 5/8"
± 4 lbs

CAST IRON V-GROOVE WHEELS

INCLUDES: ROLLER BEARINGS, ZIRK FITTING, SLEEVE, AXLE & NUTS

WHEEL DIAMETER	WEIGHT	WHEEL TYPE	AXLE SIZE	MAX CAPACITY
4" x 1-1/2"	2.954	CAST IRON	1/2"	800 lbs
6" x 2"	6.252	CAST IRON	1/2"	800 lbs



6" Cast Iron



4" Cast Iron

Axles included with wheels

V-GROOVE AND POWER WHEELS ROLL ON 1" ANGLE

12" WELDABLE SPRING CLOSER

± 1.31 lbs Per Piece



For Gates or Doors; Black with Heavy Duty Screws - Adjustable

STEEL TUBING RINGS FROM 1/2" □ SQUARE TUBING

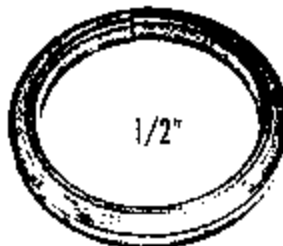

Improved
Quality;
Straighter
Profile &
Better Seam

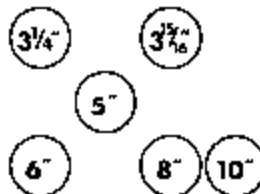

Rolled From 1/2" Square Tubing
16 Gauge - Tack Welded

Outside Diameters
Some may vary by +/- 1/8"

WEIGHT	OUTSIDE DIAMETER
.177 lbs	3-1/4"
.240 lbs	3-15/16"
.310 lbs	5"
.370 lbs	6"
.510 lbs	8"
.640 lbs	10"

STEEL LOCK BOXES

**1" WIDE
SINGLE BOX**

**BUBBLE BOX
OFFSET GUARD**

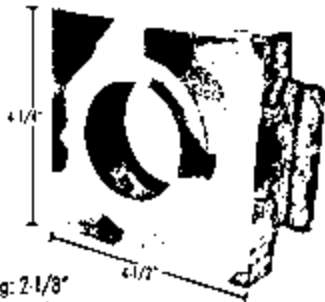

Opening: 2-1/8"
Backset: 2-3/8"
± .932 lbs

**1-1/4" WIDE
SINGLE BOX**

**BUBBLE BOX
STRAIGHT GUARD**

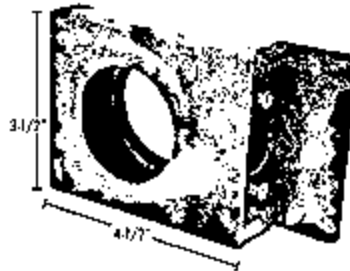

Opening: 2-1/8"
Backset: 2-3/8"
± .908 lbs

**1-5/16" WIDE
DOUBLE BOX**

CRIMPED GUARD



Opening: 2-1/8"
Backset: 2-3/8"
± .876 lbs

**1" WIDE
DOUBLE BOX**

**BUBBLE BOX
OFFSET GUARD**

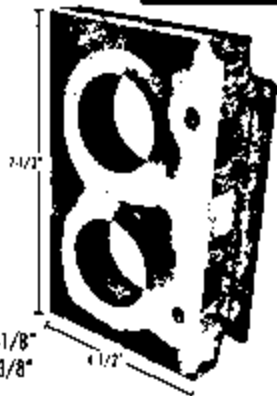

Opening: 2-1/8"
Backset: 2-3/8"
± 1.585 lbs

**1-1/4" WIDE
DOUBLE BOX**

**BUBBLE BOX
STRAIGHT GUARD**



Opening: 2-1/8"
Backset: 2-3/8"
± 1.63 lbs

**1-1/2" WIDE
DOUBLE BOX**

STRAIGHT GUARD

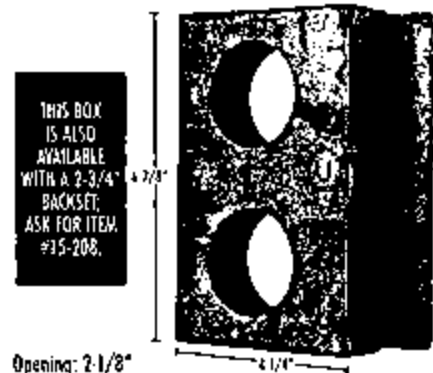

Opening: 2-1/8"
Backset: 2-3/8"
± 1.496 lbs

METAL FINISH SUPPLY FINISHES FOR METAL

METAL FINISHES

- EASY PLATE - Instantly plates a thin layer of real copper upon the surface of steel
- ANTIQUE PEWTER - Darkens most metals to yield an antique pewter finish
- RAINBOW PATINA - Works on real copper and copper alloys to produce shades of brown
- EASY TORCH - Used with easy plate finish to produce an effect similar to applying high heat upon metal
- ANTIQUE BLACK - Used to blacken or darken steel to produce an antique effect
- ANTIQUE RED BROWN - Used on steel to produce a dark reddish brown finish
- EASY BLUE - Used on steel to produce a dark bluish black

ALLOY AND STEEL METALLIC COATINGS

Real metallic alloy flakes or powdered steel suspended in a glue like latex glaze base. Metallic coatings can be applied to almost any surface, causing the substrate material to take on the appearance of the corresponding metal. The surface may then be oxidized using one or more of the oxidizers to produce beautiful rusts and patina effects.

- COPPER GLAZE
- BRASS GLAZE
- GOLD GLAZE
- BRONZE GLAZE
- DARK BRONZE GLAZE

COPPER OXIDIZERS

- BLUE-GREEN PATINA
- GREEN PATINA
- LIGHT BLUE PATINA

Copper oxidizers are for use on copper and copper alloy metallic coatings. Oxidizes copper and the metal in the metallic coatings to produce a wide variety of blue, green, turquoise, and other colors.

INSTA-RUST OXIDIZERS

- EASY RUST LIGHT
- EASY RUST MEDIUM
- EASY RUST DARK

Insta-Rust instantly begins the rust process on most types of steel. A multitude of rust effects can be produced in a short time span, ranging from several minutes to a few hours.

Stocked Sizes

<u>DESCRIPTION</u>	<u>8 OZ.</u>	<u>QUART</u>	<u>GALLON</u>	<u>5 GALLON</u>
ANTIQUE BLACK	X	X	X	
ANTIQUE PEWTER	X	X	X	
ANTIQUE RED-BROWN	X	X	X	
CLEAR ACRYLIC GLOSS		X	X	
CLEAR ACRYLIC MATTE		X	X	
EASY BLUE	X	X	X	
EASY PLATE	X	X	X	X
EASY RUST DARK	X	X	X	X
EASY RUST MEDIUM	X	X	X	X
EASY RUST LIGHT	X	X	X	X
EASY TORCH	X	X	X	X
BRASS GLAZE	X	X	X	
BRONZE GLAZE	X	X	X	
DARK BRONZE GLAZE	X	X	X	
COPPER GLAZE	X	X	X	
GOLD GLAZE	X	X	X	
BLUE-GREEN PATINA	X	X	X	
GREEN PATINA	X	X	X	
LIGHT BLUE PATINA	X	X	X	
RAINBOW PATINA	X	X	X	
REACT ARREST	X	X	X	X

Approximate coverage 450 sq ft / gallon



* WOLF

CHOICE STEEL COMPANY

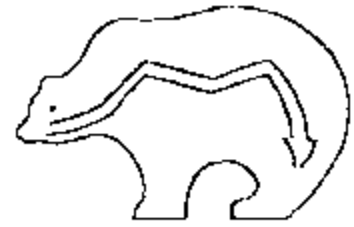

* ZUNI BEAR



* QUAIL



* ROAD RUNNER

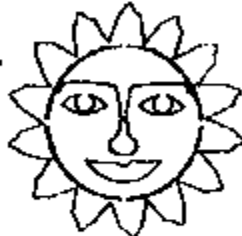

FATHER SUN



* SUN SWIRL



* TRAILS END



JAVELINA

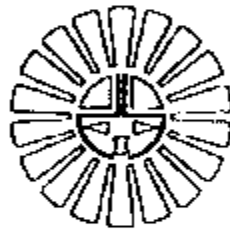

* INDIAN SUN



* LIZARD



MOOSE

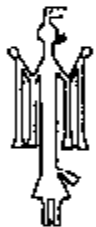

YEI



* GRIZZLY BEAR



* KOKOPELLI



* ELK



* EAGLE



COWBOY



SAGUARO



* BULL RIDER



* BUFFALO



* BRONCO BUSTER



BOOT



* BUCKING HORSE

* Designs kept in stock. All are 12" 10ga. and 6" 14ga., except sun designs which are 24" 16ga. and 6" 14ga..

REQUIREMENTS FOR CUSTOM BURN OUTS

We require a black (representing the part being cut out) and white (representing the drop or waste) picture on an 8 ½ x 11 sheet of paper. The black must be smooth lines. See example below. The better the picture the better the results. Or we need an AUTO CAD file in .dwg or .dxf format. All burn outs can be scaled proportionately from 3 ½" x 3 ½" to 8' x 20'. Pricing is based on thickness of material, size of part, and a setup/programming fee.

